

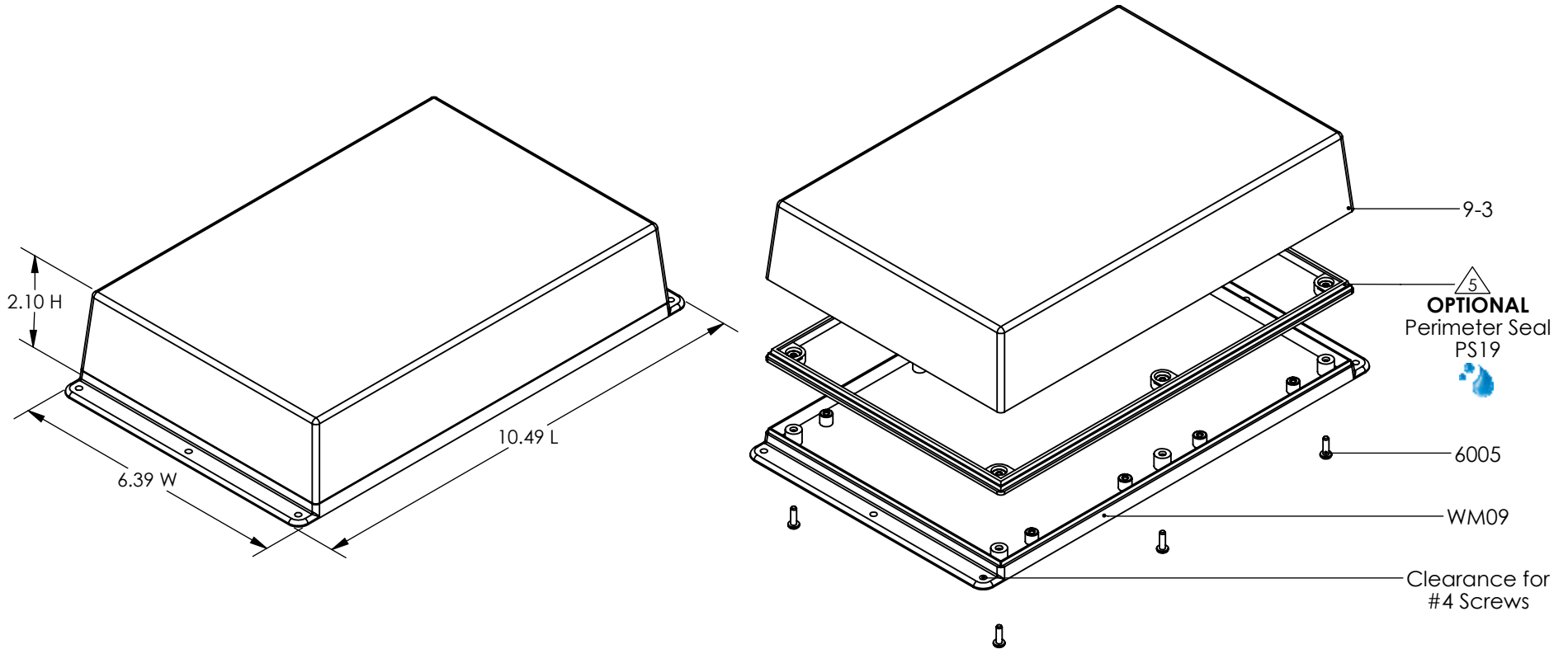

SERPAC WM093

ELECTRONIC ENCLOSURES



PART NO.	DESCRIPTION (Included)	ACCESSORIES (Optional)	
9-3	Top	PART NO.	DESCRIPTION
WM09	Wall Mounted Bottom	60	Standoff Hole
6005	#4X3/8" Self-Tapping Screw (6)	61	Standoff Post
		PS19	Waterproof Perimeter Seal
		1040	2AA Battery Holder

Notes: Enclosure weight .70 lb / 317 g

- 1) Enclosure meets or exceeds IP40 and NEMA 1
- 2) Circuit Board drawings see sheet 3.
- 3) All components are RoHS Compliant.
- 4) Material: Top and Bottom ABS.
- 5) When used with PS19 the enclosure meets or exceeds IP 67 and NEMA 4X, 12 and 13 MIL-STD-810G 506.5 (.04 lb / 19g) 

SERPAC WM093

ELECTRONIC ENCLOSURES

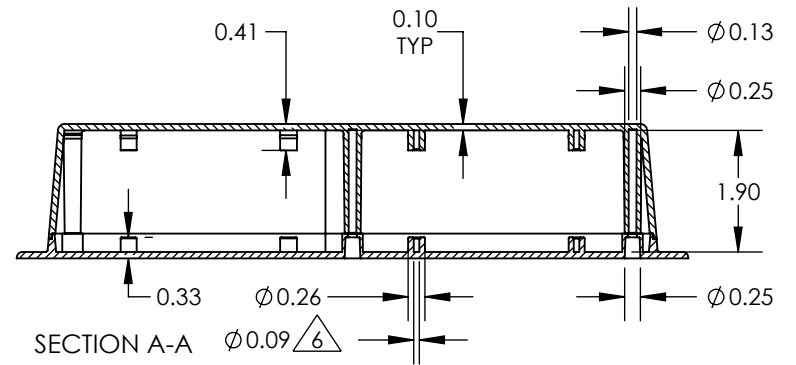
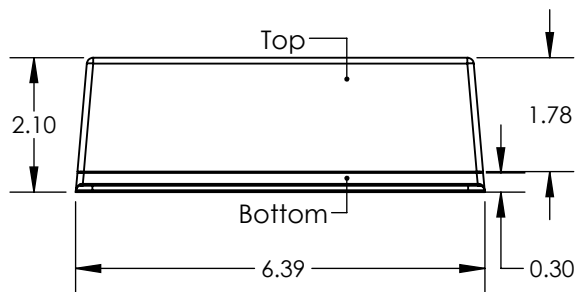
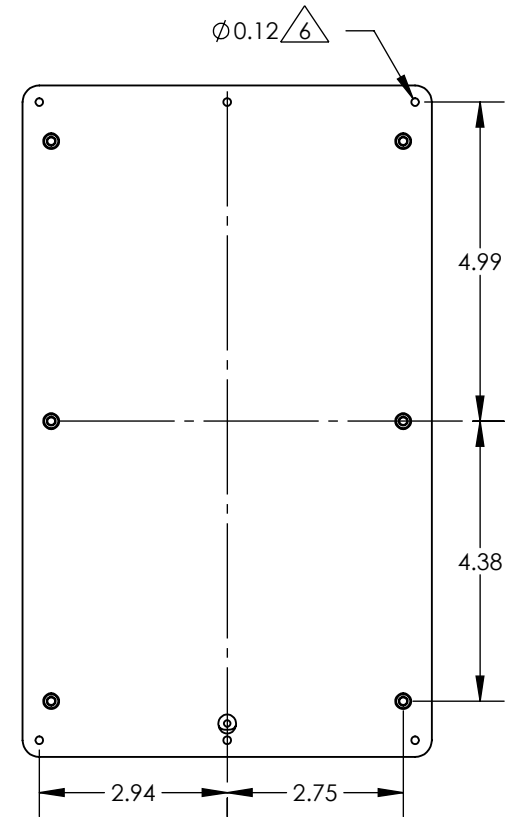
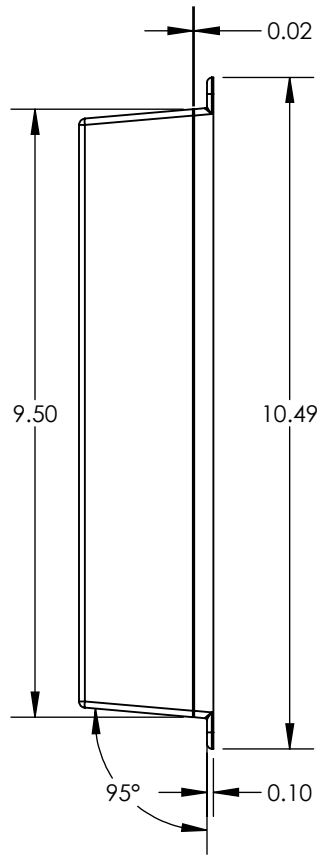
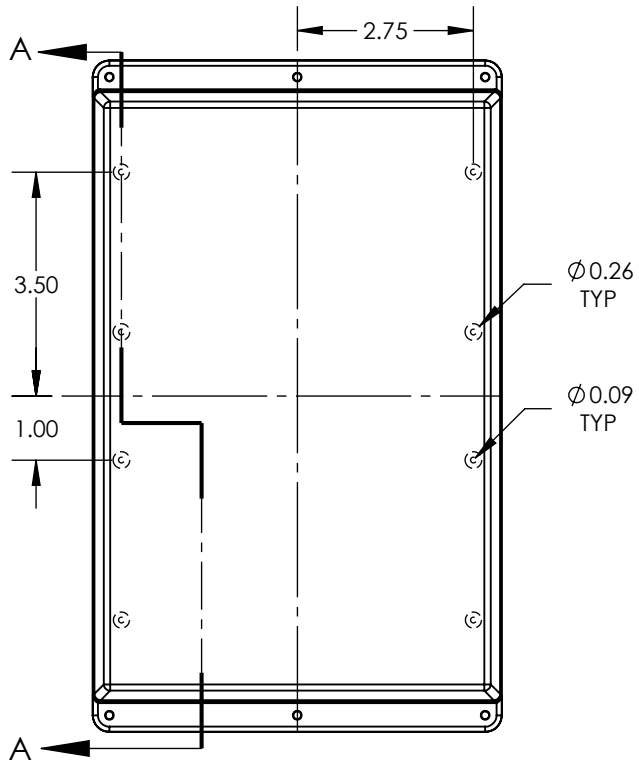

- Notes:
- 1) Enclosure weight .70 lb / 317 g
 - 2) Enclosure meets or exceeds IP40 and NEMA 1
 - 3) Circuit Board drawings see sheet 3.
 - 4) All components are RoHS Compliant.
 - 5) Material: Top and Bottom ABS.
 - 6) When used with PS19 the enclosure meets or exceeds IP 67 and NEMA 4X, 12 and 13 MIL-STD-810G 506.5 (.04 lb / 19g)
 - 7) Accepts #4 self tapping screw. $\triangle 6$

SERPAC WM093 CIRCUIT BOARD

ELECTRONIC ENCLOSURES

Top & Bottom Option

